

FREZZA[®]

K

evo

k evo

Tutti gli spazi sono in costante relazione visiva attraverso le vetrate che delimitano gli ambienti. Il progetto k evo offre un sistema monolatra con profili monocava a regolazione variabile, in grado di assorbire le tolleranze dimensionali delle parti murarie.

All spaces visually connect each other through the glasses that define the surrounding spaces. The K evo partition wall is a single glazed system with single hollow profiles and variable adjustment to absorb the dimensional wall tolerance.

Alle Räume sind im konstanten Sichtkontakt durch die Glaeser, die die verschiedene Bereiche abgrenzen. Das K evo Trennwand bietet ein einzeln Glas System mit einzelmem Hohlprofil und variable Höhenverstellung an, um die Wand Maßtoleranzen aufnehmen zu können.

Tous les espaces sont en relation visuelle constante à travers le verre qui entourent les ambiances de travail. La cloison K evo est un système de profils en aluminium qui permet le placement d'un seul verre soit de 10mm, soit de 12mm en fonction de la hauteur. Les profils sont pourvus d'un système de vérins afin d'ajuster les inégalités entre le sol et le plafond.

Todos los espacios están en constante relación visual a través de las ventanas que rodean los ambientes. La pared de división K evo es un sistema de vidrio único con perfiles huecos simples y ajuste variable para absorber la tolerancia de la pared dimensional.













PORTA BATTENTE CON TELAIO E SOPRALUCE

Framed hinged doors with transom / Drehtüren mit Rahmen und oberlicht / Porte battante encadrée et imposte
Puertas batientes con marco y fijo superior







I vetri delle pareti sono stratificati e sono disponibili nelle versioni trasparente, acidato, serigrafato oppure decorati tramite pellicola adesiva. È inoltre possibile utilizzare vetri stratificati con maggior abbattimento acustico.

The glasses of the walls are stratified and are available in clear, frosted, silk-screen printed or decorated glass with the application of an adhesive film. It's also possible to use stratified glasses with a higher noise reduction.

Die Glasmodule sind geschichtet und aus transparentem Glas, sowie auch aus Mattglas, mit Siebdruck oder Klebefolien Dekor erhältlich. Außerdem ist das Version aus transparentem Glas mit Akustikfolien erhältlich.

Les verres sont stratifiés et disponibles en version transparente, dépoli, sérigraphié ou décorés avec un film adhésif. Il est prévu aussi la version du verre stratifié avec une plus grande réduction du bruit.

Los módulos de cristal estratificado son disponibles en cristal transparente, satinado, serigrafiado, con aplicación de películas adhesivas decorativas. Adicionalmente es disponible la versión en cristal transparente con película acústica.













AUTOPORTANZA

Freestanding structure / Freistehende Struktur / Structure autoportante / Estructura autoportante



K EVO WITH SPAZIO MODULO PARTITION



Soluzioni tecniche che si integrano e dialogano tra loro.

Technical solutions that integrate and interact with each other .

Technische Lösungen, die sich integrieren und die miteinander kommunizieren.

Les solutions techniques qui intègrent et communiquent les uns avec les autres.

Las soluciones técnicas que se integran y se comunican entre sí.

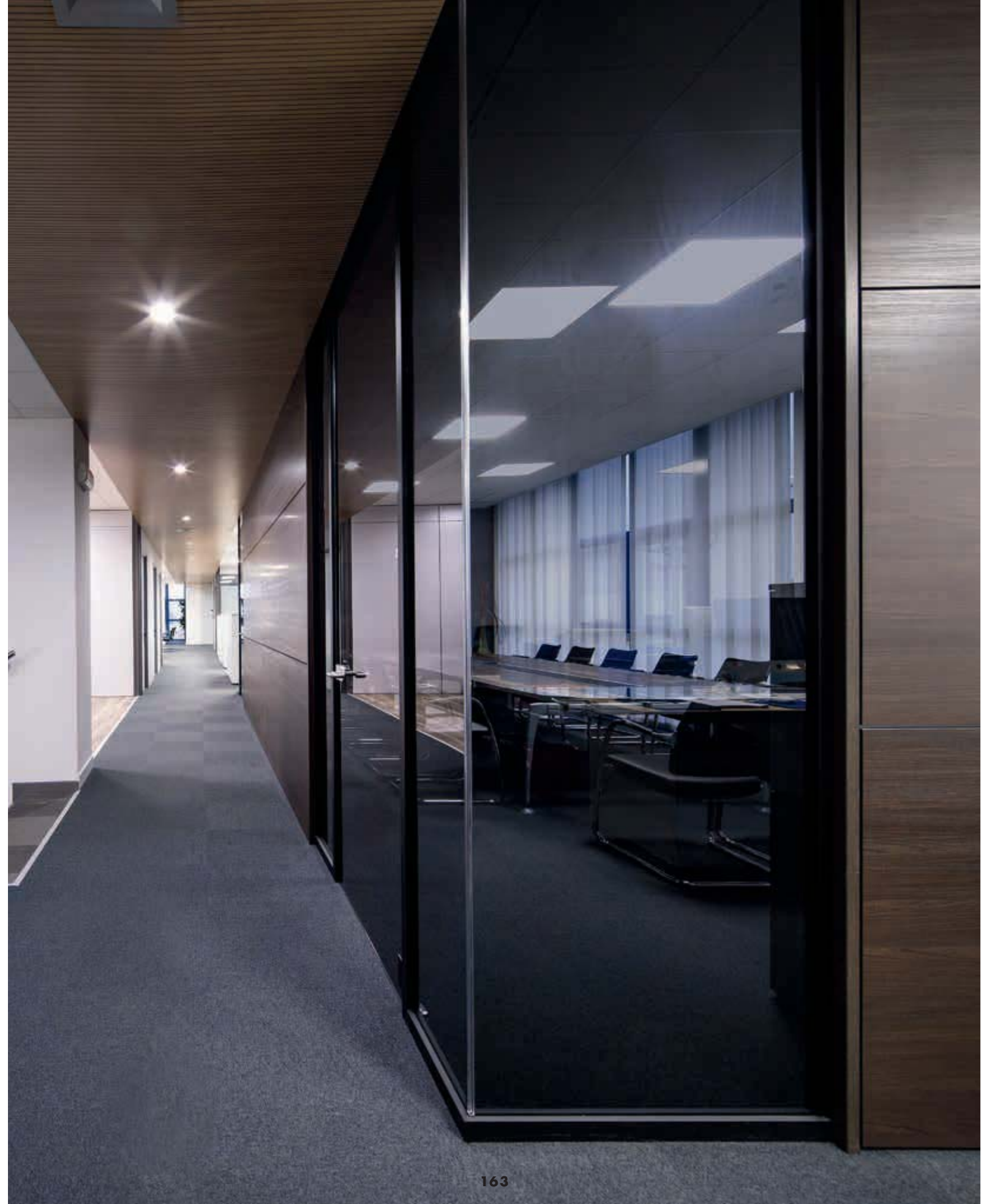







SEZIONI VERTICALI

Vertical Sections / Vertikalschnitte / Sections verticales / Secciones verticales



Parete divisoria vetrata
Glazed partition wall
Verglaste Wand
Cloison vitrée
Mampara acristalada

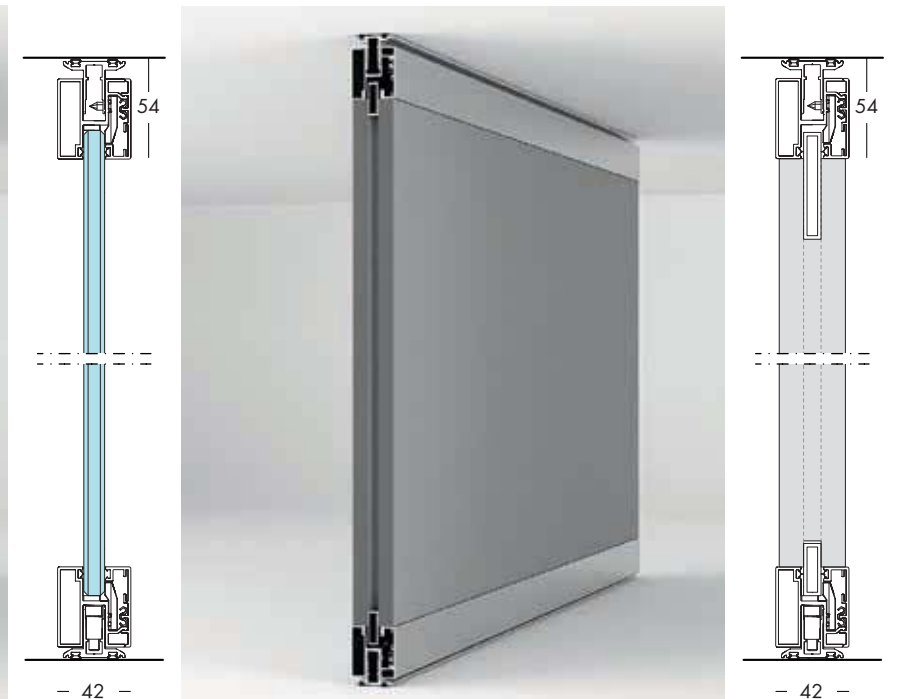

Parete divisoria cieca
Solid partition wall
Vollwand
Cloison pleine
Mampara ciega



Parete divisoria mista
Mixed partition wall
Gemischte Wand
Cloison mixte
Mampara mixta

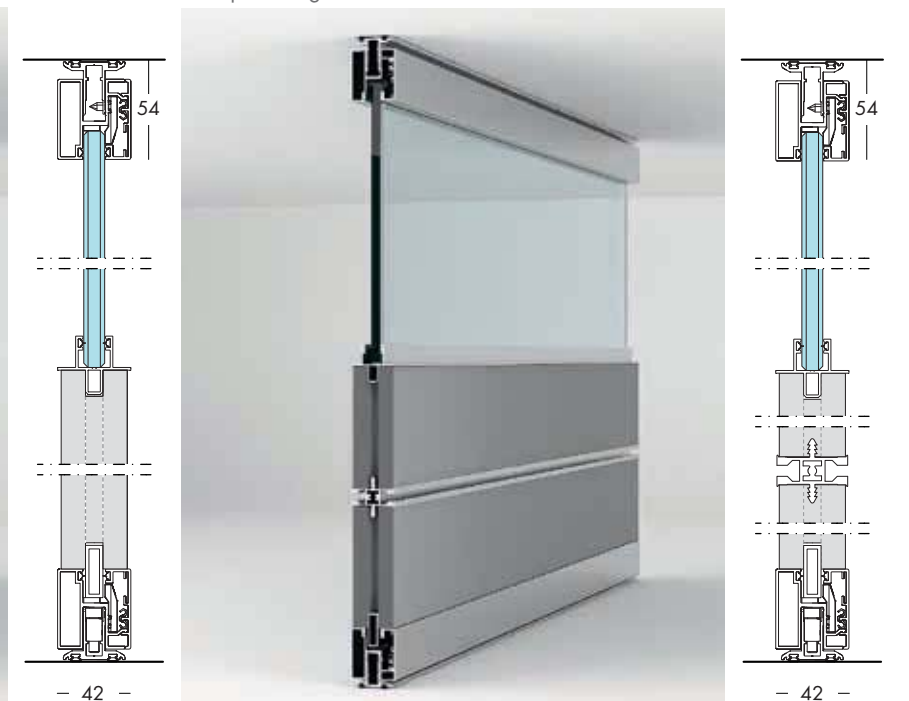

Parete divisoria mista con profilo attrezzabile in alluminio
Mixed partition wall with aluminium profile
Gemischte Wand mit aluminiumprofil
Cloison mixte avec profil en aluminium
Mampara mixta con perfil aluminio equipable



Elemento per partenza da muro
 Wall post for partition wall
 Maueranschlusselement
 Profil pour fixation au mur
 Arranque a pared

GIUNTI DI CONNESSIONE IN POLICARBONATO

Polycarbonate joint / Polykarbonateckverbindung / Jonction en polycarbonate / Perfiles de conexion en polycarbonato

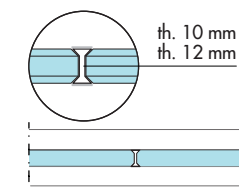

th. 10 mm
 th. 12 mm
 Giunto lineare 2 vie in polycarbonato 180 °
 2-Ways polycarbonate linear joint 180 °
 2 Wege Linearverbindung aus Polycarbonat 180 °
 Jonction linéaire 2 voies en polycarbonate 180 °
 Perfil de conexion en polycarbonato a 180°

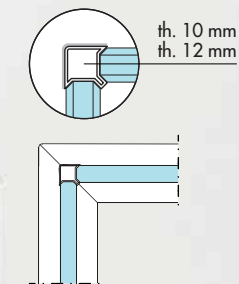

th. 10 mm
 th. 12 mm
 Giunto angolare 2 vie in polycarbonato 90 °
 2-Ways polycarbonate 90° corner joint
 2 Wege Eckverbindung aus Polycarbonat 90 °
 Jonction angle 2 voies en polycarbonate 90 °
 Perfil de conexion en polycarbonato a 90°

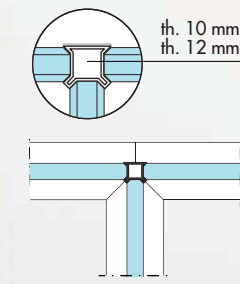
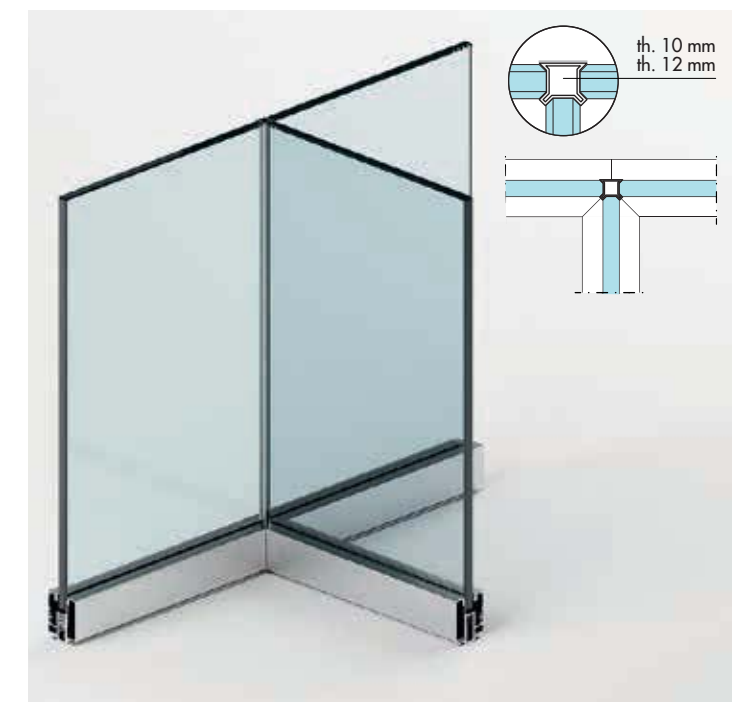

th. 10 mm
 th. 12 mm
 Giunto angolare 3 vie in polycarbonato 90 °
 3-Ways polycarbonate 90° corner joint
 3 Wege Eckverbindung aus Polycarbonat 90 °
 Jonction angle 3 voies en polycarbonate 90 °
 Perfil de conexion en polycarbonato a 3 vias 90 °

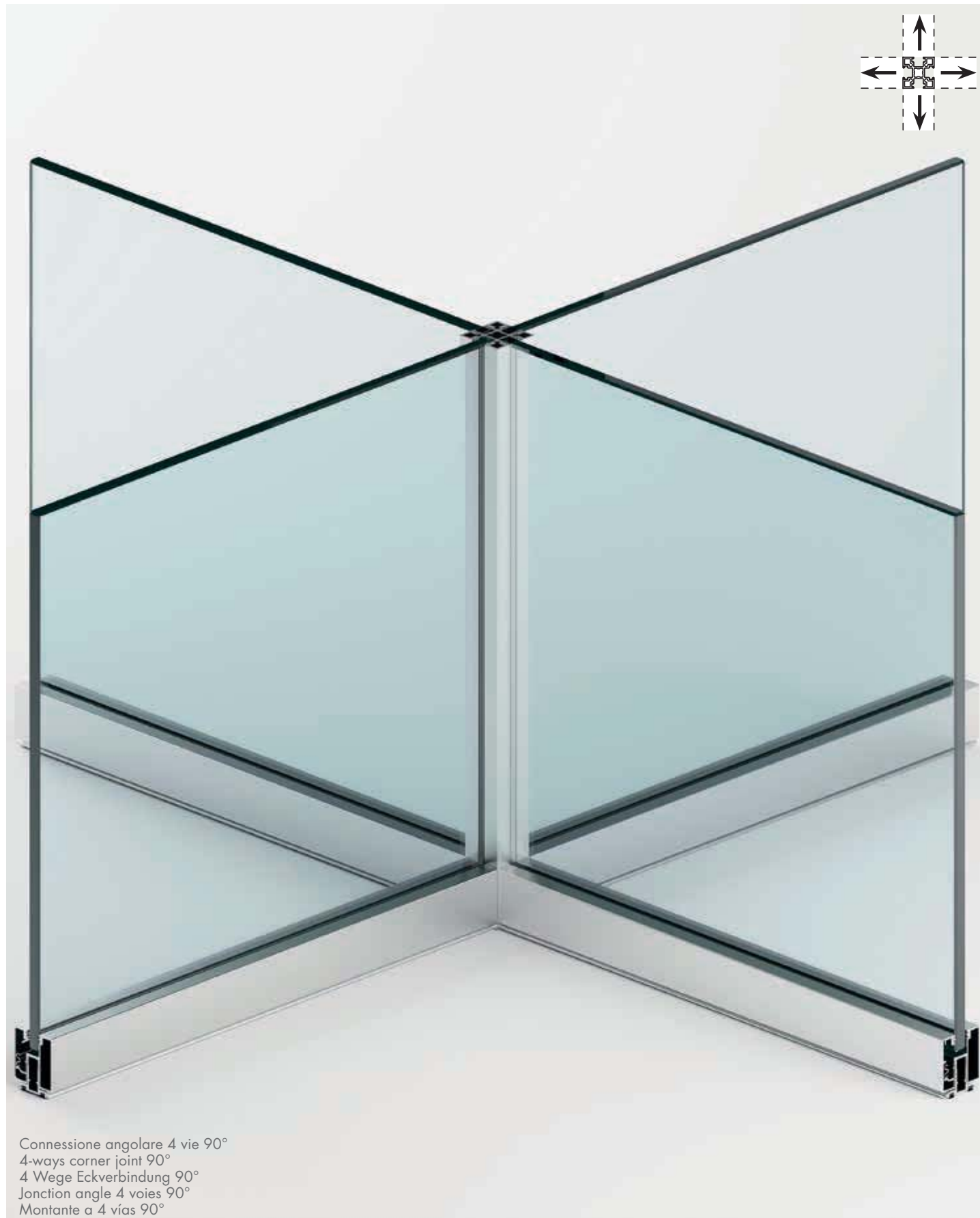

Connessione angolare 4 vie 90°
 4-ways corner joint 90°
 4 Wege Eckverbindung 90°
 Jonction angle 4 voies 90°
 Montante a 4 vías 90°

MONTANTE ANGOLARE

Corner upright / Eckverbindung / Montant angle / Montante de connexion



Connessione 1 via
 1-Way joint
 1 Weg Verbindung
 Jonction 1 voie
 Montante a 1 via



Connessione lineare 2 vie 180°
 2-Way 180° corner joint
 2 Wege Linearverbindung 180°
 Jonction linéaire 2 voies 180°
 Montante a 2 vías 180°



Connessione angolare 2 vie 90°
 2-Way 90° corner joint
 2 Wege Eckverbindung 90°
 Jonction angle 2 voies 90°
 Montante esquinero 90°



Connessione angolare 3 vie 90°
 3-Way 90° corner joint
 3 Wege Eckverbindung 90°
 Jonction angle 3 voies 90°
 Montante a 3 vías 90°

MONTANTE ANGOLARE VARIABLE Variable angle junction element
 Variable Eckverbindung / Montant angle variable / Montante de conexión con ángulos variables



Connessione angolare variabile a 2 vie
 Variable angle 2-ways junction element
 2 Wege variable Eckverbindung
 Jonction angle variable 2 voies
 Montante con ángulos variables esquinero

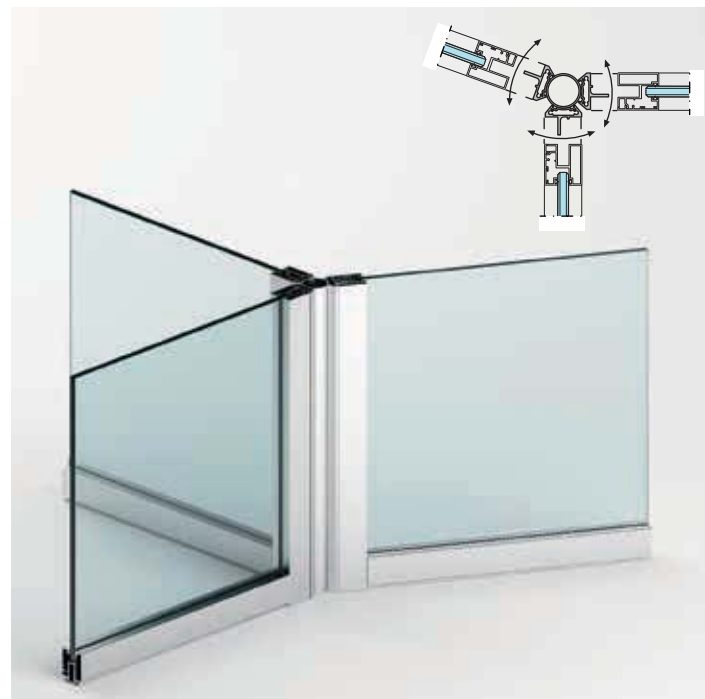

Connessione angolare variabile a 3 vie
 Variable angle 3-ways junction element
 3 Wege variable Eckverbindung
 Jonction angle variable 3 voies
 Montante con ángulos variables a 3 vías



VANO TECNICO DI ELETTTRIFICAZIONE Technical compartment for cable management
 Technische Element für Elektrifizierung / Élément technique pour électrification / Elemento técnico para electrificación

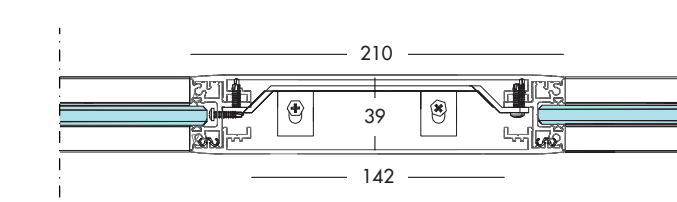

Vano tecnico in alluminio ispezionabile
 Aluminium cable compartment inspectable
 Alu-Technikelement durchsichtbar
 Compartiment technique en aluminium inspectable
 Elemento técnico de aluminio Inspeccionable

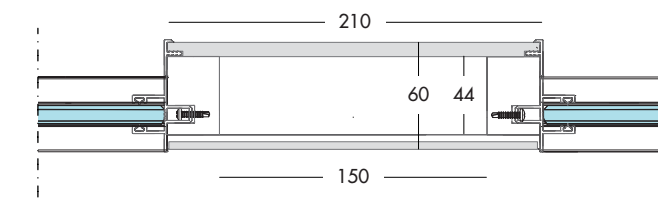

Vano tecnico in melaminico
 Melamine technical compartment
 Melamin-technikelement
 Élément technique en melamine
 Elemento técnico de melamina



PORTE BATTENTI

Hinged doors / Drehtüren / Portes battantes / Puertas batientes

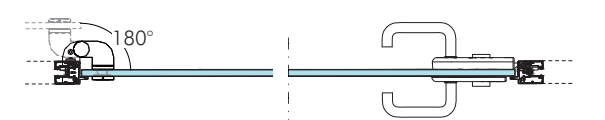
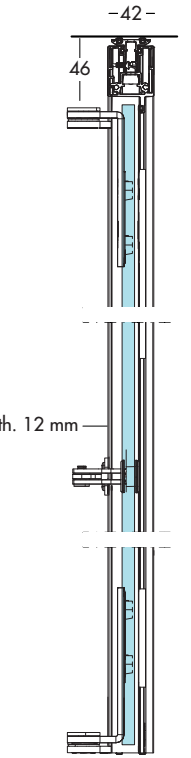
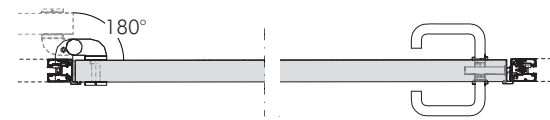
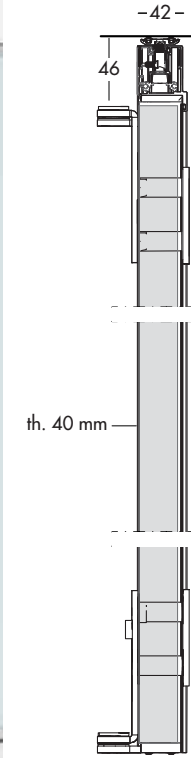

PORTE BATTENTI

Hinged doors / Drehtüren / Portes battantes / Puertas batientes

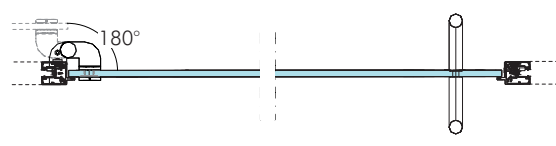
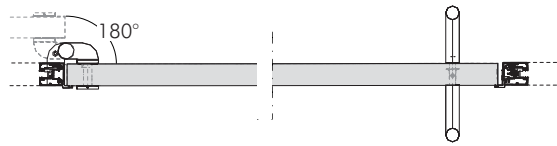
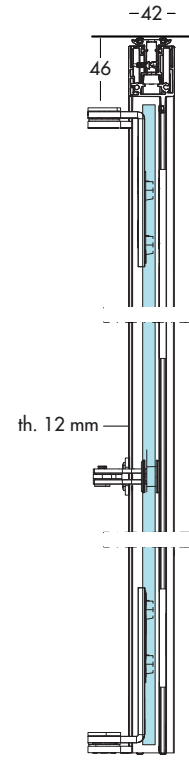
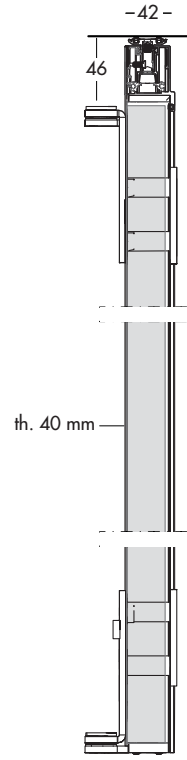

PORTE BATTENTI CON TELAIO

Framed hinged doors / Drehtüren mit Rahmen / Portes battantes encadrée / Puertas batientes con marco

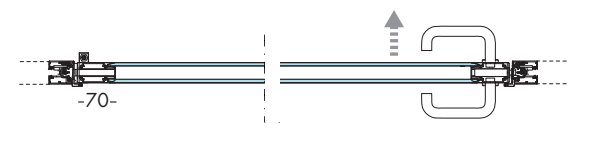
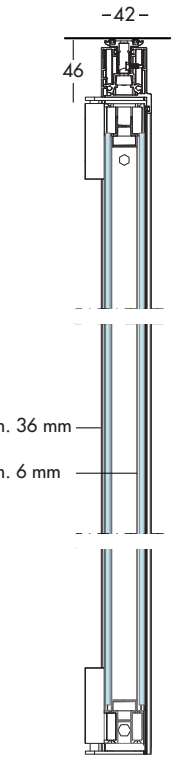
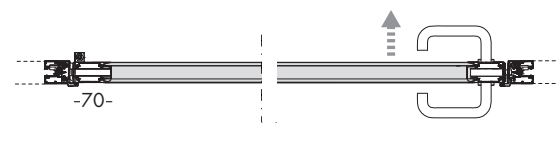
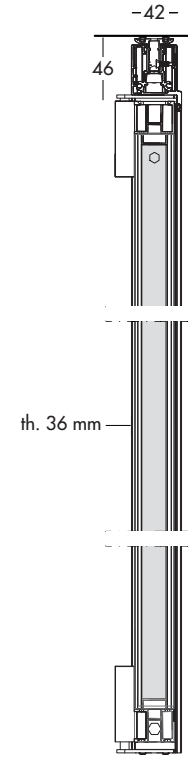
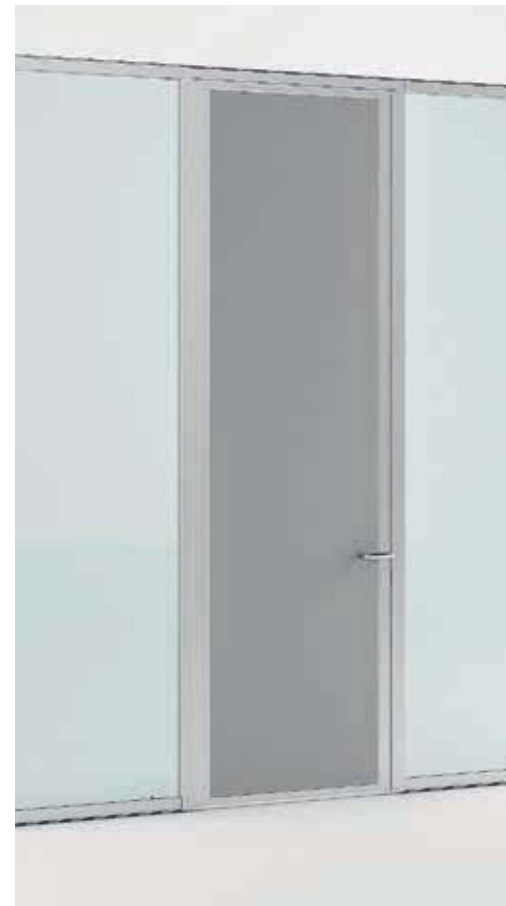

PORTE SCORREVOLI

Sliding doors / Schiebetüren / Portes coulissantes / Puertas correderas

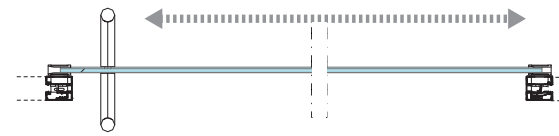
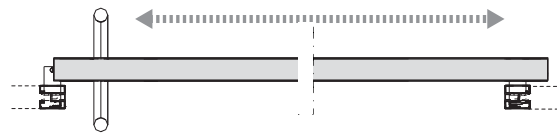

MANIGLIE PORTE BATTENTI

Handles for swing doors / Griffe für Flügeltür / Poignées pour portes battantes / Manijas para puertas batiente



Maniglia per porta battente cieca
Handle for solid hinged door
Griff für Hölztür
Poignée pour porte pleine
Manilla para puerta batiente de madera



Maniglia per porta battente cieca
Handle for solid hinged door
Griff für Hölztür
Poignée pour porte pleine
Manilla para puerta batiente de madera



Maniglia per porta battente cieca
Handle for solid hinged door
Griff für Hölztür
Poignée pour porte pleine
Manilla para puerta batiente de madera

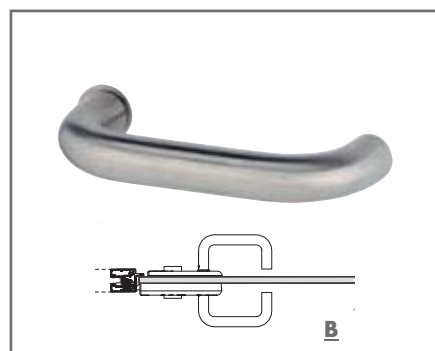

Maniglia porta battente vetro con serratura
Handle for glass hinged door with lock
Griff für Glastür mit Schloss
Poignée pour porte vitrée avec serrure
Manilla para puerta batiente acristalada con cerradura

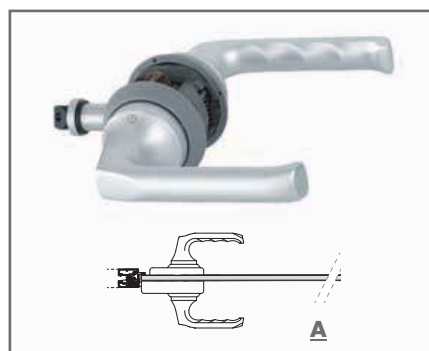

Maniglia porta battente vetro con serratura
Handle for glass hinged door with lock
Griff für Glastür mit Schloss
Poignée pour porte vitrée avec serrure
Manilla para puerta batiente acristalada con cerradura



Maniglia porta battente vetro con serratura
Handle for glass hinged door with lock
Griff für Glastür mit Schloss
Poignée pour porte vitrée avec serrure
Manilla para puerta batiente acristalada con cerradura



Maniglia per porta battente cieca con telaio
Handle for framed hinged door
Griff für tür mit Rahmen
Poignée pour porte encadrée
Manilla para puerta batiente enmarcada



Maniglia per porta battente cieca con telaio
Handle for framed hinged door
Griff für tür mit Rahmen
Poignée pour porte encadrée
Manilla para puerta batiente enmarcada

MANIGLIONI PORTE

Handles for doors / Griffe für Türen / Poignées pour portes / Manijas para puertas



Maniglione
Ladder pull
Griff
Poignée
Manilla
> L. 300 mm

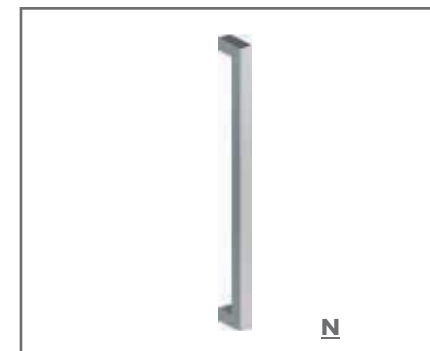

Maniglione
Ladder pull
Griff
Poignée
Manilla

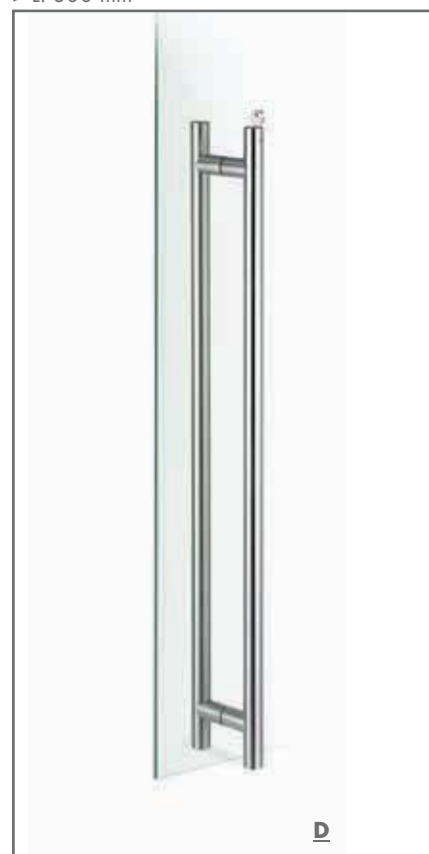

Maniglione in acciaio inox con/senza serratura
Stainless steel ladder pull with/without lock
Griff inox Stahl mit/ohne Schloss
Poignée tubulaire en acier inox avec/sans serrure
Manilla en acero inox con/sin cerradura
> L. 1150 mm

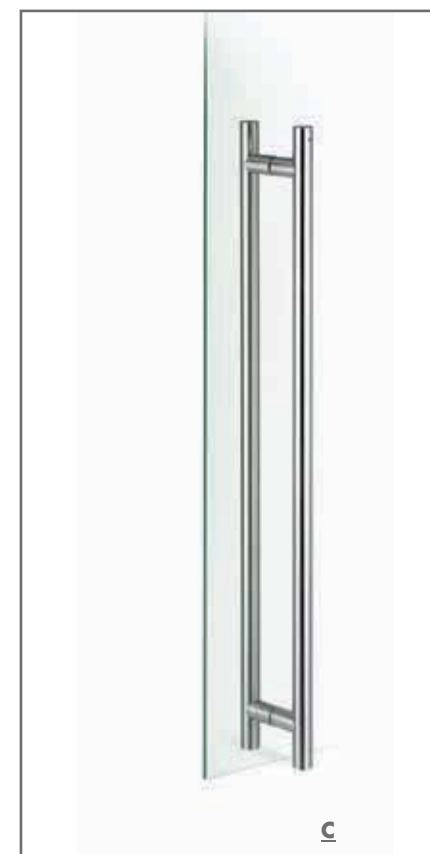

Maniglione in acciaio cromato senza serratura
Chrome plated steel ladder pull without lock
Griff Verchromter Stahl ohne Schloss
Poignée tubulaire en acier chromé sans serrure
Manilla en acero cromado sin cerradura
> L. 1150 mm